

A	B	C (mm)		D
1	S331-013	916	460	1/1
2	S331-114	924	412	1/1
3	S331-202	930	450	1/1
4	S331-213	930	433	1/1
5	S331-302	898	390	1/1
6	S331-917	934	909	1/1

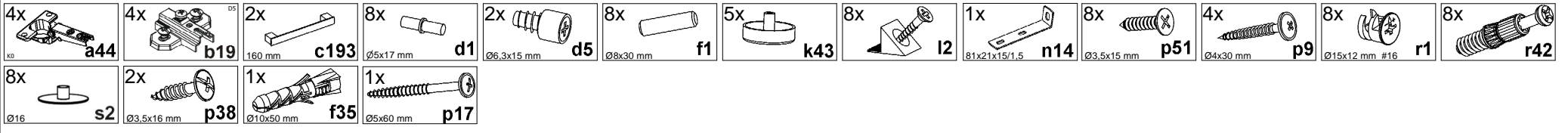

1 

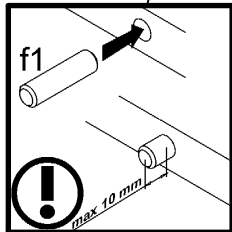
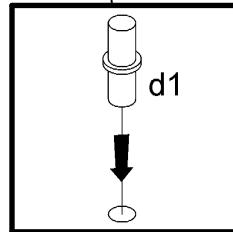
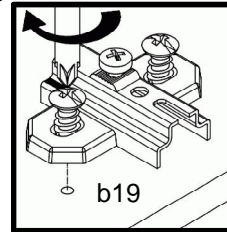
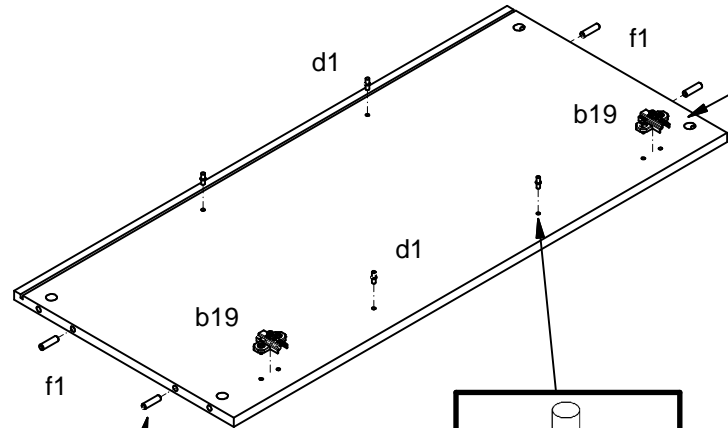

2 

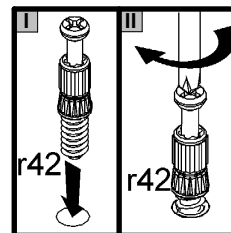
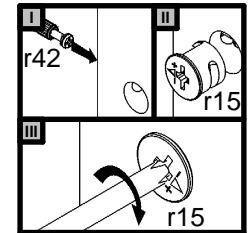
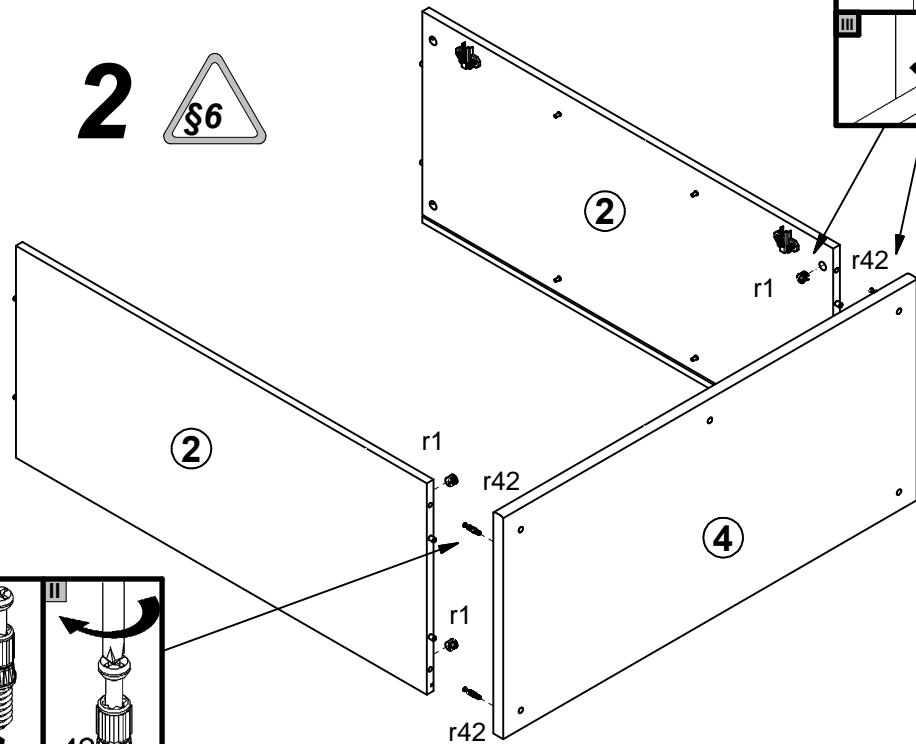

3

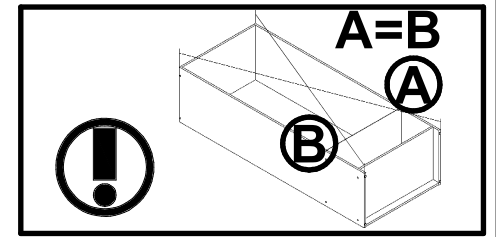
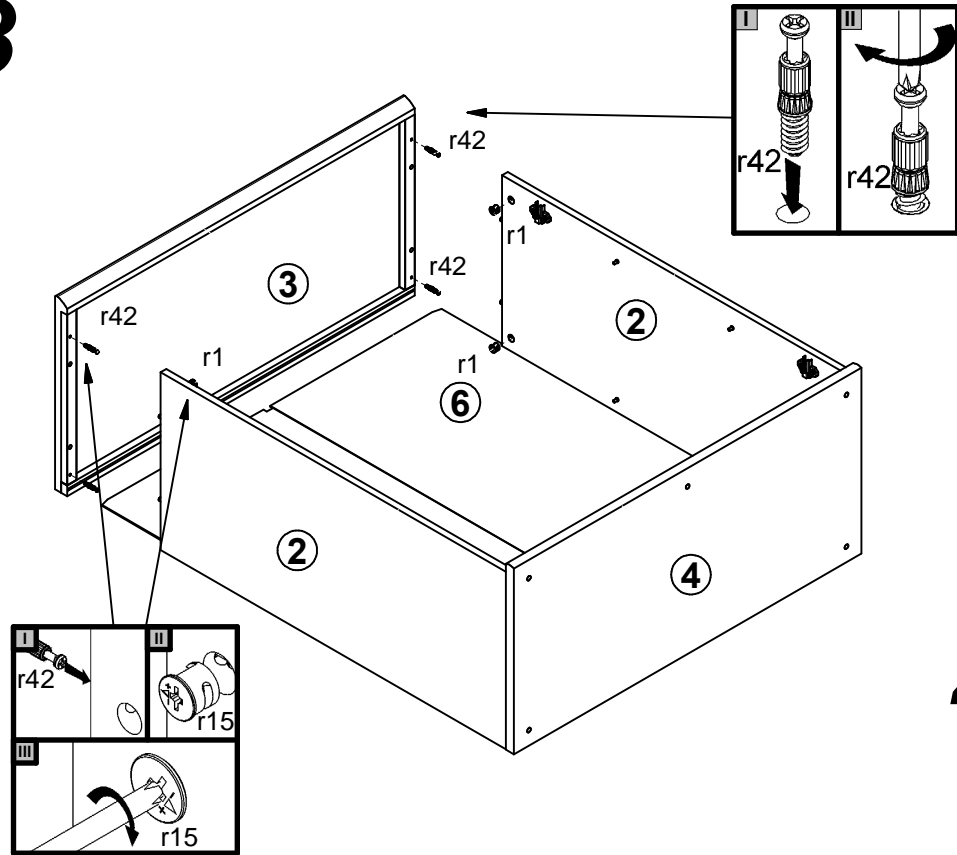

4

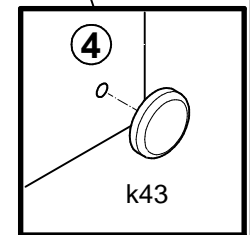
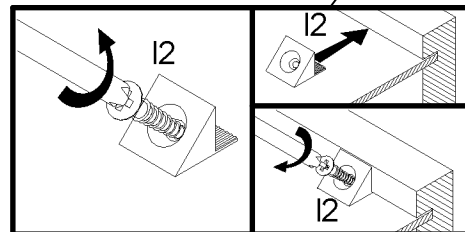
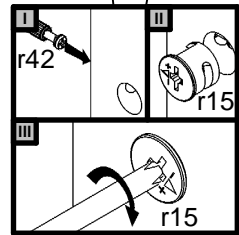
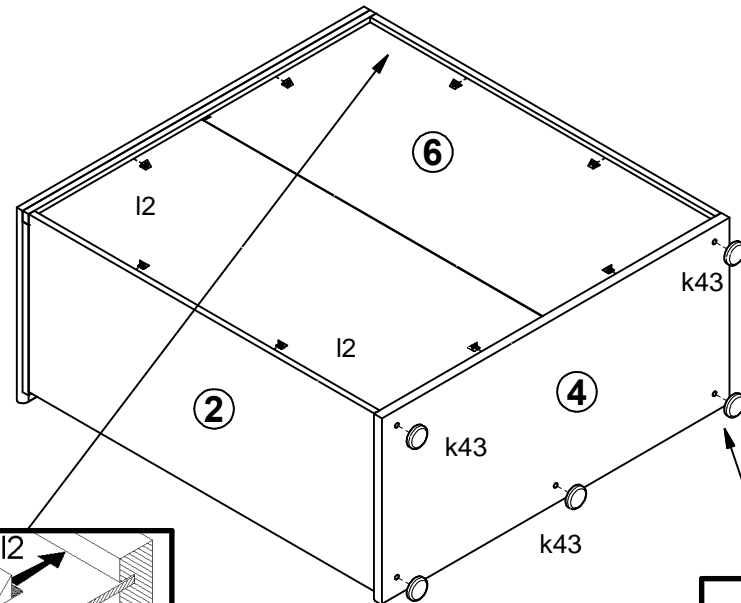

5

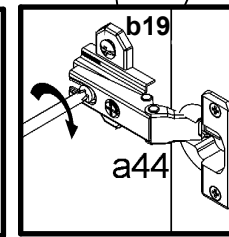
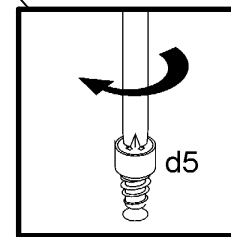
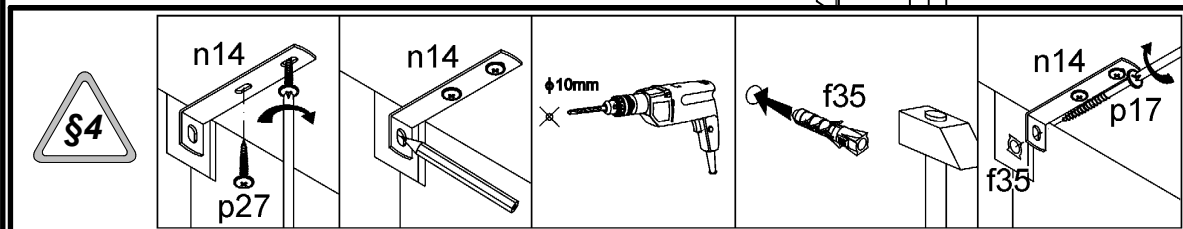
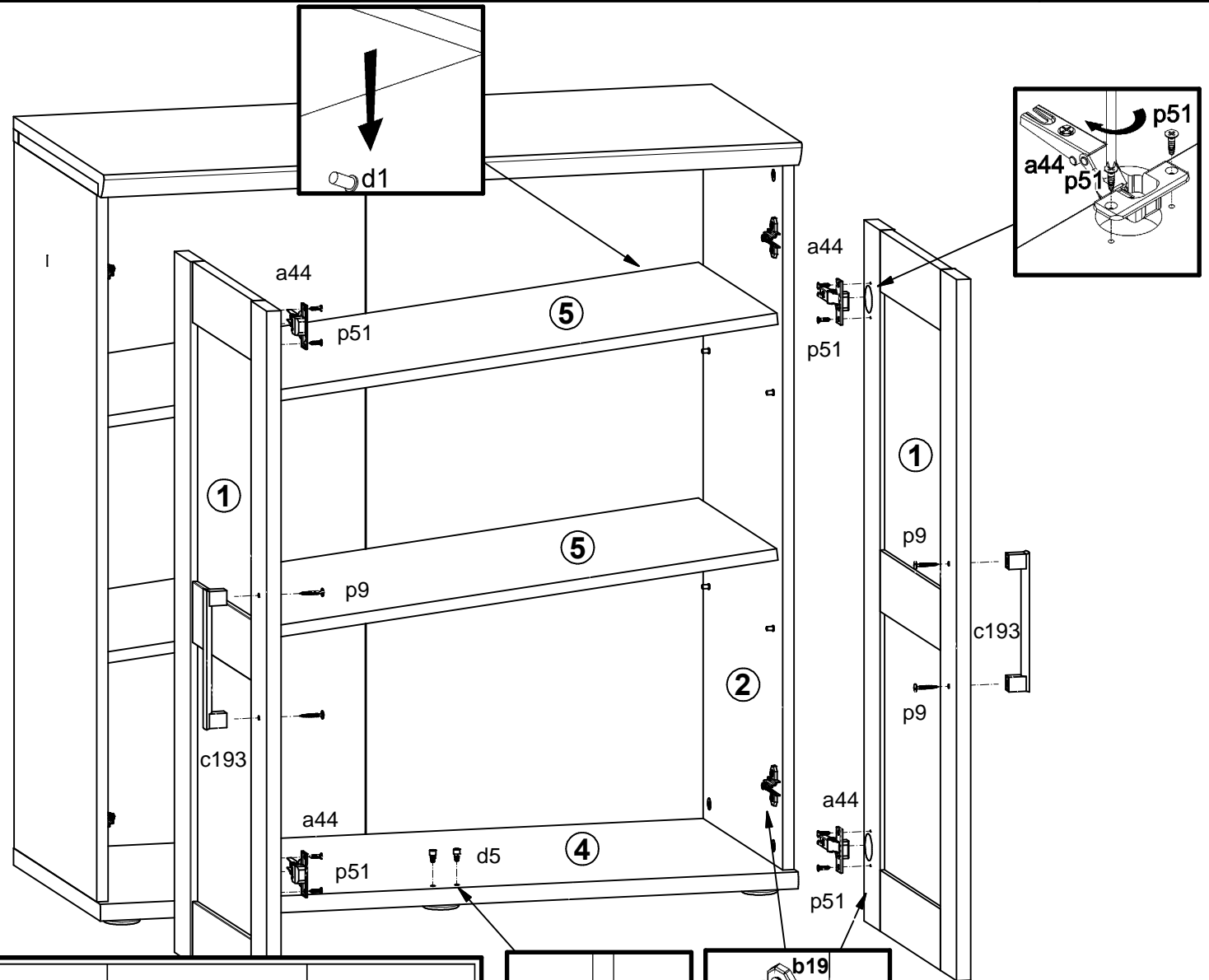

6

