

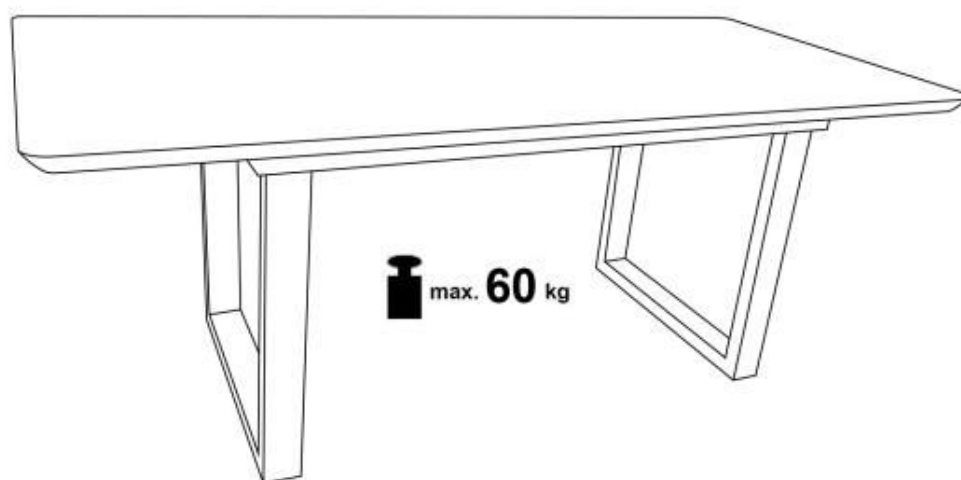

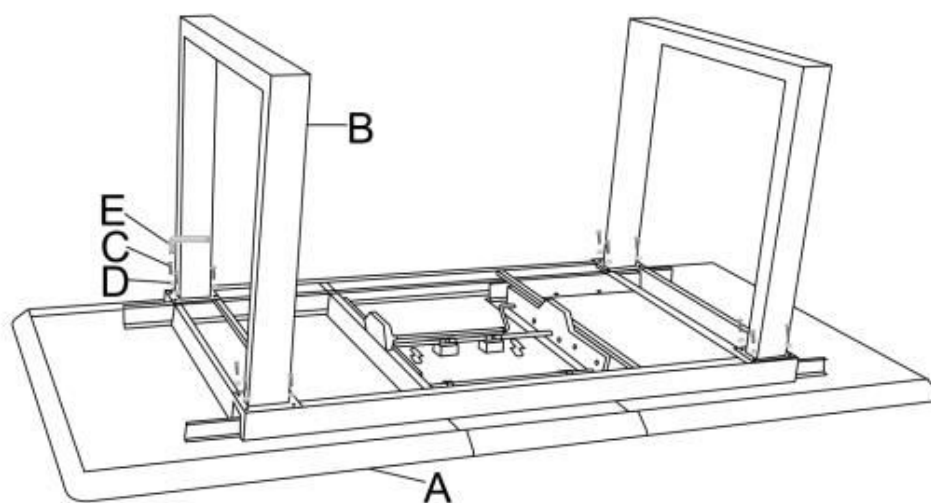



# MARLEY



v.1

Ax1	Bx2	Cx16	Dx16	Ex1
		 M8*25	 Ø8*18	 M5

HALMAR Sp. z o.o.

ul. Centralnego Okręgu Przemysłowego 2, 37-450 Stalowa Wola, POLSKA / POLAND  
tel. +48 15 843 28 10, fax: +48 15 842 19 57, e-mail: office@halmar.com.pl

**NOWOŚĆ**